

Rowenta

Powerglide 2

Instructions for use

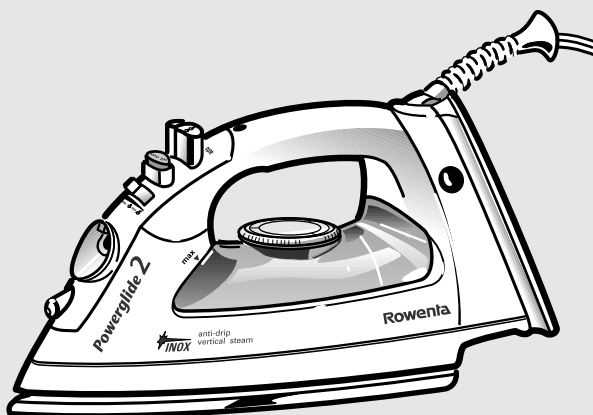

IMPORTANT SAFEGUARDS

When using your iron, basic safety precautions should always be followed, including the following:

Read all instructions before using the iron.

1. Use iron only for its intended use.
2. To protect against a risk of electric shock, **do not** immerse the iron in water or other liquids.
3. The iron should always be turned to minimum (min) before plugging or unplugging from outlet. Never yank cord to disconnect from outlet, instead grasp plug and pull to disconnect.
4. Do not allow cord to touch hot surfaces. Let iron cool completely before putting away. Loop cord loosely around iron when storing.
5. Always disconnect iron from electrical outlet when filling iron with water, emptying iron or when not in use.
6. Do not operate iron with a damaged cord or if the iron has been dropped or damaged. To avoid the risk of electric shock, do not disassemble the iron, take it to the nearest authorized Rowenta Appliance Service Center for examination and repair. Incorrect reassembly can cause a risk of electric shock when the iron is used.
7. Close supervision is necessary for any appliance being used by or near children. Do not leave iron unattended while connected or on an ironing board.
8. Burns can occur from touching hot metal parts, hot water or steam. Use caution when you turn a steam iron upside down – there may be hot water in the reservoir.
9. The use of accessory attachments is not recommended by Rowenta Appliance Company and may result in fire, electric shock or personal injury.

SPECIAL INSTRUCTIONS

1. This is a 1400 watt appliance. To avoid a circuit overload, do not operate another high wattage appliance on the same circuit.
2. If an extension cord is absolutely necessary, a 12-ampere cord should be used. Cords rated for less amperage may overheat. Care should be taken to arrange the cord so that it cannot be pulled or tripped over.
3. After the iron has cooled, wrap the cord loosely around the heel.
4. Your Rowenta appliance is intended for household use only.

SAVE THESE INSTRUCTIONS

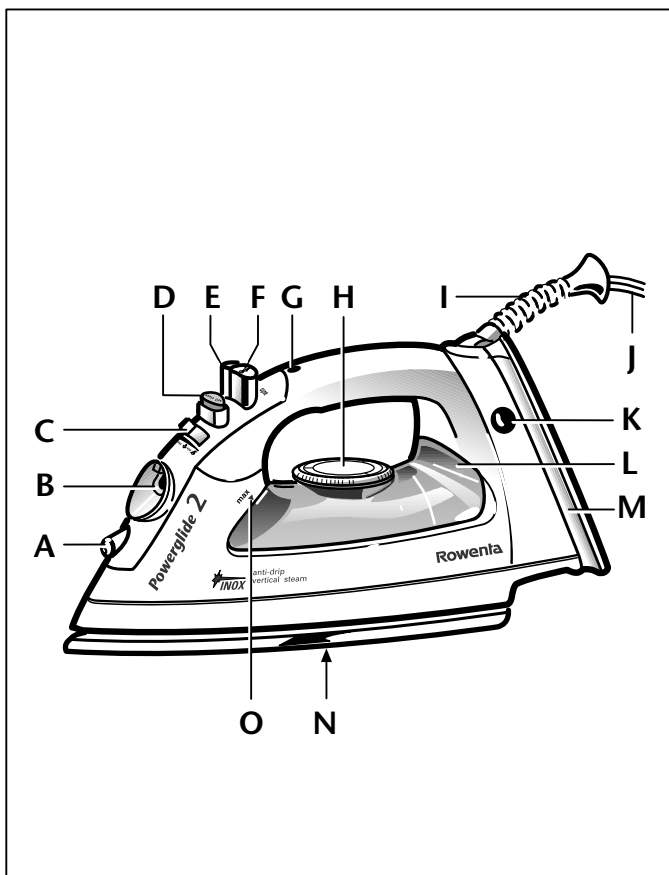

■ **Description:**

- A Spray nozzle
- B Water filling inlet
- C Variable steam control
- D Self clean button
- E Spray button
- F Burst of steam button
- G Auto-off indicator light
(depending on model)
- H Temperature control dial
- I Swiveling cord protector
- J Supply cord
- K Temperature light
- L Transparent water tank
- M Cord wrap
- N Soleplate according to model
 - Stainless steel
 - Titan Plus
- O Maximum water level indicator

Features vary by model. Check packaging or markings on iron for exact features.

BEFORE USE

- Please read the instructions for use and the **Important Safeguards** carefully.
- Slowly peel the protective cover off the soleplate or remove the transparent soleplate protector.
- It is normal for a small amount of smoke to be produced the first time the iron is used. This will quickly disappear.

3-WAY AUTO-OFF (depending on model)

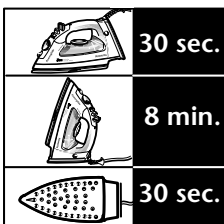

- If the iron is not moved while it is plugged in, an internal safety switch will turn it off. It will turn off in 8 minutes if left vertically or in 30 seconds if left on its soleplate or tipped over. A red flashing light indicates that the auto-off has been activated. To switch the iron on again, move the iron or gently shake it.

Wait until iron is fully reheated before use.

STEAM IRONING

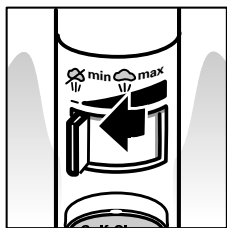

Filling with water

- Ensure the iron is unplugged.
- Slide the variable steam control completely to the left to shut off the steam valve.
- Hold the iron upright so that the water filling inlet is horizontal.
- Fill the iron with tap water up to the maximum level mark (see water usage for more information).

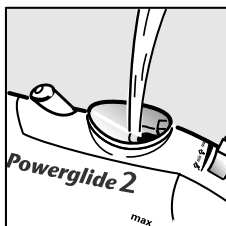

Adding water

- If you need to add water during ironing, **UNPLUG** the iron and repeat above steps.
- Ensure iron is fully reheated after filling (temperature indicator light goes out) before ironing.
- To avoid damage to clothes from dust or dirt that may collect in the iron, we recommend that for the first use or after the iron has been stored for some time that you first iron an old cloth, testing both the steam and burst of steam feature.

SELECTING THE TEMPERATURE

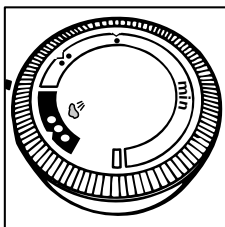

Set the temperature control dial according to the type of fabric you are ironing. Check the fabric's label for appropriate setting.

- synthetics (low temperature)
- silk, wool (medium temperature)
- cotton, linen (high temperature)

To avoid an automatic switch off while the iron is heating up, always keep the iron on its heel. Start at low temperature and graduate to high temperature. For delicate fabrics we recommend carrying out a test on an unobtrusive part of the garment (inner seam).

SETTING VARIABLE STEAM CONTROL

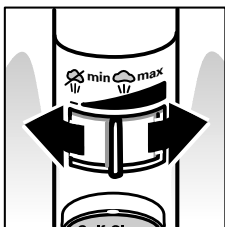

Set the variable steam control to required steam volume. Steam can only be produced when the thermostat is in the red cotton/linen zone. Allow iron to heat up (light goes out) before activating the variable steam control. Reduce or set variable steam to min. when ironing at low temperatures to avoid water leakage or spitting.

Iron ready for steam ironing

Steam is produced as soon as the iron is held horizontally.

Steam off

Steam generation can be interrupted by standing the iron on its heel or sliding the variable steam control fully to the left.

SPRAY SETTING

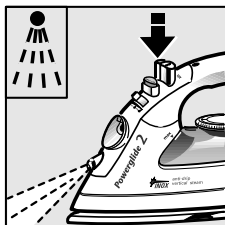

- Ensure there is water in the tank.
- Moistening the fabric with the spray will make wrinkle removal easier.
- Press the spray button down slowly for a jet or quickly and strongly for a mist.
- Do not spray silk, etc.

BURST OF STEAM

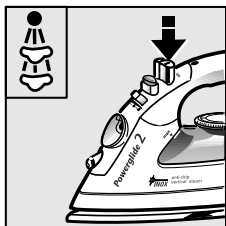

- To remove stubborn wrinkles or press in a sharp crease, use the burst of steam button.
- Press the button firmly, a strong burst of steam penetrates deep into the fabric.
- Leave an interval of at least four seconds between pressing the burst of steam button.
- With water in the tank, the burst of steam button can be used as soon as the steam ironing temperature has been reached (●●●)

Vertical steam

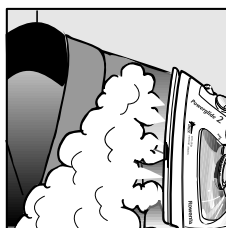

- The iron can also be used vertically. This is especially useful for getting creases out of hanging clothes, curtains, draperies, etc.

WARNING:
Never iron clothes while they are being worn.

DRY IRONING

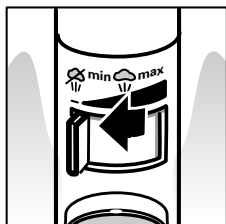

- Slide the variable steam control fully to the left. We recommend dry ironing with an empty tank to be sure there are no drips, but it can also be performed with water in the tank.

AFTER IRONING

- Unplug the iron. Slide the variable steam control completely to the left (the minimum position) and empty any water left in the tank. Leave the iron to cool down.

Integrated cord wrap

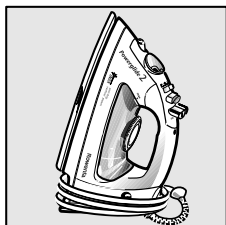

- For easy storage, the cord can be wound **loosely** around the heel **once the iron has cooled down completely.**
- To protect the soleplate always store the iron on its heel.

WATER TO USE IN ROWENTA IRONS

Tap water

Rowenta irons are designed to be used with REGULAR TAP WATER (up to 12 grains of hardness). If your water is harder than this, Rowenta recommends mixing half tap water with half distilled water which reduces the hardness; or use undiluted inexpensive bottled spring water.

Never use 100% distilled water since this can cause the iron to spit and leak.

Softened water

There are many types of household water softeners and the water from many of them is perfectly acceptable for use in an iron. However, some types of softeners, particularly those that use chemicals such as salt, can cause the iron to leak or spit during use. If you experience this type of problem we recommend that you try using inexpensive bottled spring water or untreated tap water.

Never use 100% pure distilled water.

Once you have changed water it will take several uses to correct the problem. Rowenta recommends trying the steam function for the first time on an old towel or cloth to avoid damaging your clothes.

Iron and other impurities

If your water supply contains large amounts of iron or organic matter, these minerals can collect inside the iron and eventually appear as brown stains. If you experience these problems Rowenta recommends using inexpensive bottled spring water.

Never use 100% pure distilled water.

CLEANING AND MAINTENANCE

- When cold and unplugged, the iron can be cleaned with a damp cloth and wiped dry. Never use household cleaners or solvents.

Cleaning the soleplate

Rowenta stainless steel and Titan Plus soleplates have excellent non-stick properties and can simply be wiped clean when cold.

- In normal use a draggy coating may build up on the soleplate (starch, detergent buildup, burnt synthetic fibers). This can be easily removed by using the Rowenta Soleplate Cleaning Kit or a quality hot iron soleplate cleaner available at most stores.
- Do not use abrasive household cleaners or abrasive cleaning pads.
- To prevent scratching of the soleplate, do not iron over sharp objects (zippers, etc.). Do not place the iron on rough surfaces, e.g. metal iron support, which may scratch the soleplate.

SELF CLEANING

Your iron is equipped with two self clean functions. Do not use descaling agents in your Rowenta iron.

Vapodur® Valve

The patented Vapodur® valve ensures that the opening which allows the water to drip from the water tank into the steam chamber remains unaffected by hard water deposits.

To ensure your iron continues to steam efficiently the valve **MUST** be opened and closed a few times. This is done by moving the variable steam control left to right a few times every time you finish ironing.

Steam Chamber Cleaning Function

This function allows loose mineral deposits and other impurities that build up inside the iron to be flushed out. **This type of self cleaning only needs to be carried out occasionally and never more than once a month.**



- Fill the iron with cold tap water and set variable steam to min.
- Stand on heel and plug in.
- Set thermostat dial to maximum position.
- When the iron reaches the correct temperature, indicator light will go out, unplug iron.
- Hold iron horizontally over the sink with soleplate pointing away from body.
- Press and hold down the self clean button for about 1 minute.

WARNING: Doing this will cause steam and hot water to be ejected from the soleplate. Take all proper precautions and hold iron away from body.

- Move the iron gently back and forth and side to side until all water has run through.
- Carefully wipe all water and material from the soleplate with an old folded towel, as the water and minerals can stain the soleplate (although this has no effect on glide or performance).

WARNING: Iron and soleplate may still be hot, exercise care while wiping.

- Place iron on heel and leave to cool. Turn temperature dial to minimum.
- **IMPORTANT:** before using the iron after self cleaning, test steam and burst of steam on an old towel or cloth to ensure all loose material has been removed from the iron.

IRON TROUBLESHOOTING

Problem	Possible cause	Solution
Iron is leaking.	Use only tap water. Softened water. Is iron hot enough? Is auto-off activated? Overuse of the burst of steam.	NEVER USE 100% DISTILLED WATER. The iron is designed to use tap water. In very hard water areas we recommend mixing half tap water with half distilled water. If you experience leaking or spitting, change to untreated tap water or a 50/50 tap/distilled water mix or inexpensive bottled spring water. SEE INSTRUCTIONS FOR DETAILS. Set thermostat to the ●●● position. Allow iron to heat up (indicator light goes out) before using steam control. Move iron or gently shake. Allow more time between each burst.
Iron won't heat.	Is iron plugged in? Thermostat set too low? Auto-off activated?	Check plug is in socket. Turn thermostat to a higher setting. Move iron or gently shake.
Indicator light goes on and off.	This is normal.	The light goes on and off showing the thermostat is switching the heat on and off to maintain the correct temperature.
Iron does not steam.	Is variable steam control correctly set? Steam valve is clogged.	Turn variable steam control to a higher setting. Move variable steam control from min. to max. several times to clear blockage.

Store iron on heel (vertically) with steam control at min.

For more information refer to the full use instructions.

If after using the troubleshooting guide you are still experiencing problems, do not return the iron to the store, but contact Rowenta Consumer Service who will be pleased to assist you.

In the interest of improving products, Rowenta reserves the right to change specifications without prior notice.

LIMITED WARRANTY

All Rowenta products are warranted for 1 year from date of purchase against defects in material and workmanship. During this period, any Rowenta product that, upon inspection by Rowenta, is proved defective, will be repaired or replaced, at Rowenta's option, without charge to the customer. If a replacement product is sent, it will carry the remaining warranty of the original product. This warranty does not apply to any defect arising from a buyer's or user's misuse of the product, negligence, failure to follow Rowenta's instructions, use on current or voltage other than stamped on the product or alteration or repair not authorized by Rowenta. Repair or disassembly by anyone other than a Rowenta authorized service center will void the warranty. THE WARRANTIES SET FORTH HEREIN ARE EXCLUSIVE AND NO OTHER WARRANTIES, EXPRESS OR IMPLIED, INCLUDING BUT NOT LIMITED TO ANY WARRANTY OF MERCHANTABILITY OR FITNESS FOR A PARTICULAR PURPOSE OR USE, ARE MADE BY ROWENTA OR ARE AUTHORIZED TO BE MADE WITH RESPECT TO THE PRODUCT. If you believe your product is defective, bring the product (or send it, postage prepaid) along with proof of purchase to the nearest authorized Rowenta Service Center (see below). If you send the product, please include a letter explaining the nature of the claimed defect.

Rowenta Inc.

196 Boston Avenue

Medford, MA 02155 U.S.A.

Tel.: (781)396-0600

www.rowentausa.com

OFFICE LOCATION ONLY.

If your appliance needs service, ship the product to your nearest regional service center. Be sure to put your name on the outside of shipping box (no P.O. boxes please).

If in warranty, Rowenta will repair or replace product at their discretion. If the product is out of warranty, you will be advised of the cost of repair before any work begins.

Our main service centers are listed below.

Turnpike Appliance
3495A Lawson Blvd.
Oceanside, NY 11572
516-483-5596

Authorized Appliance
1644 West Ogden Ave.
Downers Grove, IL 60515
630-852-1550

Service center information is subject to change. Please visit our website at www.rowentausa.com or call our **service center information line** at 781-306-4620. The information line provides current service center information and listings in California.

Rowenta Werke GmbH
63016 Offenbach am Main